

# CENTRALPNEUMATIC®

## HIGH-VOLUME 12VDC AIR COMPRESSOR

**Model 66399**

### SET UP AND OPERATING INSTRUCTIONS

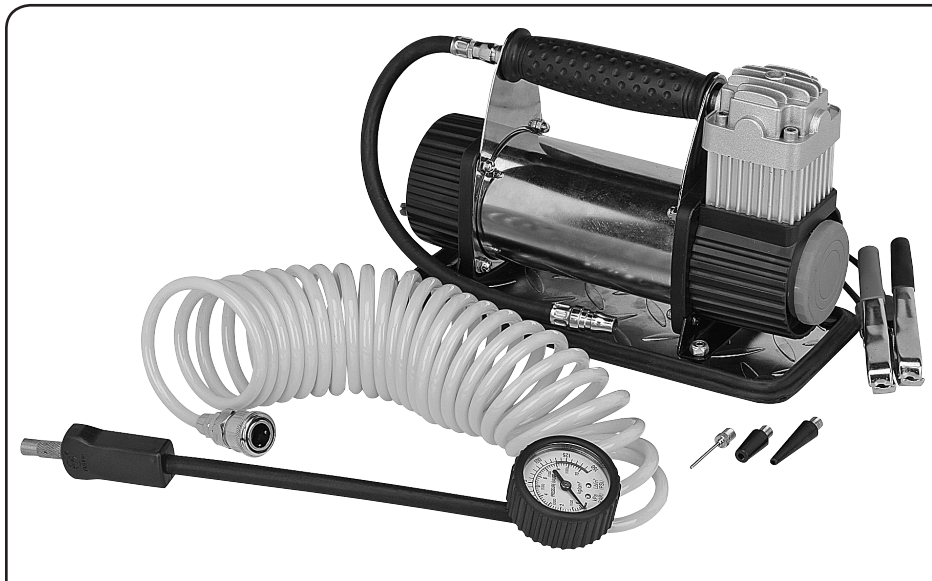

Visit our website at: <http://www.harborfreight.com>



**Read this material before using this product.  
Failure to do so can result in serious injury.  
SAVE THIS MANUAL.**

Copyright© 2008 by Harbor Freight Tools®. All rights reserved. No portion of this manual or any artwork contained herein may be reproduced in any shape or form without the express written consent of Harbor Freight Tools. Diagrams within this manual may not be drawn proportionally. Due to continuing improvements, actual product may differ slightly from the product described herein. Tools required for assembly and service may not be included.

**For technical questions or replacement parts, please call 1-800-444-3353.**

---

## SAVE THIS MANUAL

---

Keep this manual for the safety warnings and precautions, assembly, operating, inspection, maintenance and cleaning procedures. Write the product's serial number in the back of the manual near the assembly diagram (or month and year of purchase if product has no number). Keep this manual and the receipt in a safe and dry place for future reference.

---

### Safety Alert Symbol and Signal Words

In this manual, on the labeling, and all other information provided with this product:



This is the safety alert symbol. It is used to alert you to potential personal injury hazards. Obey all safety messages that follow this symbol to avoid possible injury or death.

### **⚠ DANGER**

**DANGER** indicates a hazardous situation

which, if not avoided, will result in death or serious injury.

### **⚠ WARNING**

**WARNING** indicates a hazardous situation

which, if not avoided, could result in death or serious injury.

### **⚠ CAUTION**

**CAUTION**, used with the safety alert

symbol, indicates a hazardous situation which, if not avoided, could result in minor or moderate injury.

### **NOTICE**

**NOTICE** is used to address practices not related to personal injury.

## CAUTION

**CAUTION**, without the safety alert symbol, is used to address practices not related to personal injury.

---

## IMPORTANT SAFETY INSTRUCTIONS

---

### INSTRUCTIONS PERTAINING TO A RISK OF FIRE, ELECTRIC SHOCK, OR INJURY TO PERSONS

**WARNING!** THE METAL PARTS OF THE COMPRESSOR AND HOSES WILL BECOME HOT DURING USE.

**WARNING** – When using tools, basic precautions should always be followed, including the following:

#### General

- a. To reduce the risks of electric shock, fire, and injury to persons, read all the instructions before using the tool.

#### Work area

- a. Keep the work area clean and well lighted.
- b. Do not operate the tool in explosive atmospheres, such as in the presence of flammable liquids, gases, or dust. The tool is able to create sparks resulting in the ignition of the dust or fumes.
- c. *Keep bystanders, children, and visitors away while operating the tool.* Distractions are able to result in the loss of control of the tool.

#### Personal safety

- a. *Stay alert. Watch what you are doing and use common sense when operat-*

*ing the tool. Do not use the tool while tired or under the influence of drugs, alcohol, or medication.* A moment of inattention while operating the tool increases the risk of injury to persons.

b. **Avoid unintentional starting. Be sure the switch is off before connecting to the air supply.** Do not carry the tool with your finger on the switch or connect the tool to the air supply with the switch on.

c. **Do not overreach. Keep proper footing and balance at all times.** Proper footing and balance enables better control of the tool in unexpected situations.

d.  **Always wear eye protection.** Wear ANSI-approved safety goggles.

e.  **Always wear hearing protection when using the tool.** Prolonged exposure to high intensity noise is able to cause hearing loss.

### Tool use and care

a. **Do not force the tool.** Use the correct tool for the application. The correct tool will do the job better and safer at the rate for which the tool is designed.

b. **Do not use the tool if the switch does not turn the tool on or off.** Any tool that cannot be controlled with the switch is dangerous and must be repaired.

c. **Disconnect the tool from the air source before making any adjustments, changing accessories, or storing the tool.** Turn the switch to its off position and disconnect from the battery.

d. **Store the tool when it is idle out of reach of children and other untrained persons.** A tool is dangerous in the hands of untrained users.

e. **Maintain the tool with care.**

f. **Check for misalignment or binding of moving parts, breakage of parts, air leaks, frayed wires, and any other condition that affects the tool's operation.** If damaged, have the tool serviced before using. Many accidents are caused by poorly maintained tools. There is a risk of bursting if the tool is damaged.

g. **Use only accessories that are identified by the manufacturer for the specific tool model.** Use of an accessory not intended for use with the specific tool model, increases the risk of injury to persons.

### Service

a. **Tool service must be performed only by qualified repair personnel.**

b. **When servicing a tool, use only identical replacement parts. Use only authorized parts.**





c. **Use only the lubricants supplied with the tool or specified by the manufacturer.**



**SAVE THESE INSTRUCTIONS.**

# SYMBOLS AND SPECIFIC SAFETY INSTRUCTIONS

## Symbol Definitions

Symbol	Property or statement
<b>n<sub>o</sub></b>	No-load speed
<b>.../min</b>	Revolutions or reciprocation per minute
<b>PSI</b>	Pounds per square inch of pressure
<b>ft-lb</b>	Foot-pounds of torque
<b>BPM</b>	Blows per minute
<b>CFM</b>	Cubic Feet per Minute flow
<b>SCFM</b>	Cubic Feet per Minute flow at standard conditions
<b>NPT</b>	National pipe thread, tapered
<b>NPS</b>	National pipe thread, straight
	WARNING marking concerning Risk of Eye Injury. Wear ANSI-approved eye protection.
	WARNING marking concerning Risk of Hearing Loss. Wear hearing protection.
	WARNING marking concerning Risk of Respiratory Injury. Wear NIOSH-approved dust mask/respirator.
	WARNING marking concerning Risk of Explosion.

## Specific Safety Instructions

- THE METAL PARTS OF THE COMPRESSOR AND HOSES WILL BECOME HOT DURING USE.**
- Do not use cigarette lighter adaptor to power this unit.** If powered with the battery of a vehicle, start and run engine during inflation period.
- The warnings and precautions discussed in this manual cannot cover all possible conditions and situations that may occur. It must be understood by the operator that common sense and caution are factors which cannot be built into this product, but must be supplied by the operator.
- WARNING:** Some dust created by power sanding, sawing, grinding, drilling, and other construction activities, contains chemicals known [to the State of California] to cause cancer, birth defects or other reproductive harm. Some examples of these chemicals are:
  - Lead from lead-based paints
  - Crystalline silica from bricks and cement or other masonry products
  - Arsenic and chromium from chemically treated lumber
 Your risk from these exposures varies, depending on how often you do this type of work. To reduce your exposure to these chemicals: work in a well ventilated area, and work with approved safety equipment, such as those dust masks that are specially designed to filter out microscopic particles. (California Health & Safety Code § 25249.5, *et seq.*)  
**WARNING:** The brass components of this product contain lead, a chemical known to the State of California to cause birth defects (or other reproductive harm). (California Health & Safety code § 25249.5, *et seq.*)
- Only use with accessories rated to handle the forces exerted by this tool during operation. Other accessories not designed for the forces generated may break and forcefully launch pieces.
- Attach all accessories properly to the tool before connecting the air supply. A loose accessory may detach or break during operation.

## Vibration Precautions

This tool vibrates during use. Repeated or long-term exposure to vibration may cause temporary or permanent physical injury, particularly to the hands, arms and shoulders. To reduce the risk of vibration-related injury:

Anyone using vibrating tools regularly or for an extended period should first be examined by a doctor and then have regular medical check-ups to ensure medical problems are not being caused or worsened from use. Pregnant women or people who have impaired blood circulation to the hand, past hand injuries, nervous system disorders, diabetes, or Raynaud's Disease should not use this tool. If you feel any symptoms related to vibration (such as tingling, numbness, and white or blue fingers), seek medical advice as soon as possible.



**SAVE THESE INSTRUCTIONS.**

## SPECIFICATIONS

Maximum Air Pressure	115 PSI
Speed	Fills Car Tire in Approx. 3 Minutes
Air Flow	1.3 SCFM @ 40 PSI 0.9 SCFM @ 90 PSI
Rated Air Pressure	0-115
Maximum Power	12VDC, 30 AMPS
Permanently Lubricated	Do not add oil or any other lubricant

## INITIAL TOOL SET UP/ ASSEMBLY



Read the **ENTIRE IMPORTANT SAFETY INFORMATION** section at the beginning of this manual including all text under subheadings therein before set up or use of this product.

**Note:** For additional information regarding the parts listed in the following pages, refer to the Assembly Diagram near the end of this manual.

### Unpacking

When unpacking, make sure that the item is intact and undamaged. If any parts are missing or broken, please call Harbor Freight Tools at the number shown throughout the manual as soon as possible.

- This air tool may be shipped with a protective plug covering the air inlet. Remove this plug before set up.

**Note:** Air flow, and therefore tool performance, can be hindered by undersized air supply components.

1. The air hose must be long enough to reach the work area with enough extra length to allow free movement while working.
2. Turn the tool's On/Off switch to the "OFF" position; refer to Operation section for description of controls.
3. Inspect the air connections for leaks. Repair any leaks found.

## OPERATING INSTRUCTIONS



Read the **ENTIRE IMPORTANT SAFETY INFORMATION** section at the beginning of this manual including all text under subheadings therein before set up or use of this product.

Inspect tool before use, looking for damaged, loose, and missing parts. If any problems are found, do not use tool until repaired.

### Tool Set Up



#### **TO PREVENT SERIOUS INJURY:**

Do not adjust or tamper with any control or component in a way not specifically explained within this manual. Improper adjustment can result in tool failure or other serious hazards.

### Work Piece and Work Area Set Up

1. Designate a work area that is clean and well-lit. The work area must not allow access by children or pets to prevent distraction and injury.
2. Route the air hose along a safe route to reach the work area without creating a tripping hazard or exposing the air hose to possible damage. The air hose must be long enough to reach the work area with enough extra length to allow free movement while working.

### General Assembly and Operating Instructions

1. Set tool on a dry, flat, level surface.
2. To prevent accidents, turn the On/Off Switch (25) to the "OFF" position.

3. Attach the quick coupler of coiled Air Hose (59) to male connector at the end of Rubber Hose (53).

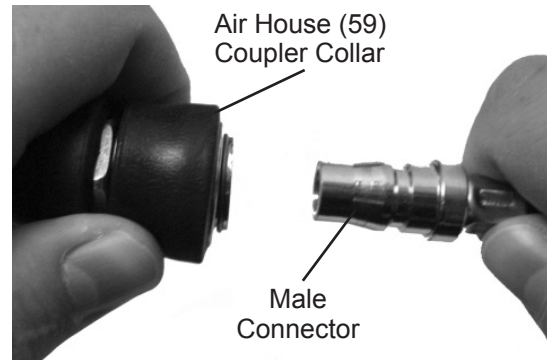

Fig. 1

4. Pull back on collar of Air Hose's coupler. Then firmly insert connector into coupler. (See Figure 1.) Release collar, which will snap connector in place. Pull lightly on both hoses to ensure proper locking in the coupler.
5. Attach the clamps on the Power Cord (27) onto the 12V automotive battery (not included) power source.
  - a. Connect RED clamp of the Compressor to the positive (+) terminal of the battery.
  - b. Connect BLACK terminal of the Compressor to a good ground source on the engine block.  
**WARNING! Do NOT connect it to the other battery terminal.**
  - c. **Note:** The power source must not exceed 12V.
6. **WARNING! Failure to follow the following steps can lead to a blown fuse.**
7. Be sure the valve stem is clean and free of dirt.

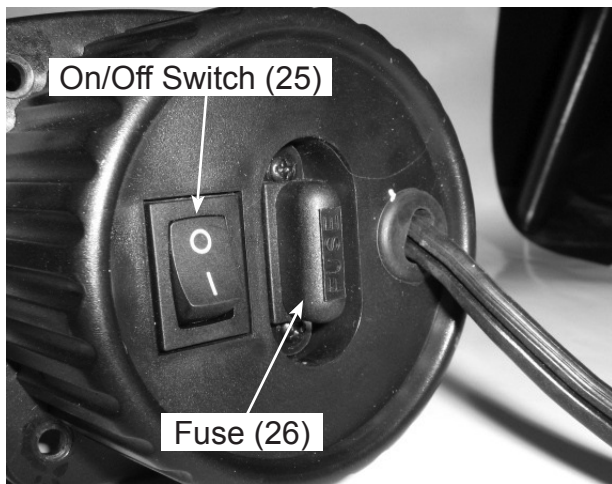

Fig. 2

8. Flip the On/Off Switch (25) to the "ON" position. (See Fig. 2.)

**Note:** Turn unit on *before* connecting to tire valve to prevent blowing the fuse.

9. Holding the Air Nozzle Grip (56), thread the Air Nozzle (55) onto the valve stem of the item to be inflated, or attach an alternate Inflator Nozzle (61,62,63).
10. **NOTE:** When inflating, finger-tighten Air Nozzle only. Do not over-tighten.



Fig. 3

11. Monitor the Pressure Gauge carefully to avoid over-inflating the item. (See Fig. 3, above.)

12. Continue inflating until the recommended pressure is reached.
13. Stop the compressor by clicking the On/Off Switch to its "OFF" position.
14. Remove the Air Nozzle by unthreading it from the valve stem.

**NOTE:** In the case of a football or soccer ball, pull the Needle Nozzle (63), out of the ball valve orifice.

**NOTE:** After disconnecting the Compressor, it is advisable to verify tire pressure with a tire pressure gauge (not included).

**NOTE:** Remember to replace the valve cap, where applicable.

15. If the tire pressure is low, repeat the steps beginning with Step 7.
16. Remove the clamps from the power source.

**WARNING! THE METAL PARTS OF THE COMPRESSOR AND HOSES WILL BECOME HOT DURING USE.**



Fig. 4

17. Allow this compressor to cool, then wipe down and replace into the storage bag supplied with this unit. (See Fig. 4.) **Note:** There is also a small

storage bag for inflator nozzles that is attached to the Rubber Hose.

18. Store in a dry location.

---

## USER-MAINTENANCE INSTRUCTIONS

---



Procedures not specifically explained in this manual must be performed only by a qualified technician.

### **WARNING**

**TO PREVENT  
SERIOUS INJURY**

**FROM ACCIDENTAL**

**OPERATION:** Turn off the tool, detach the Power supply clamps, safely discharge any residual air pressure in the tool, and release the throttle and/or turn the switch to its off position before performing any inspection, maintenance, or cleaning procedures.

**TO PREVENT SERIOUS INJURY  
FROM TOOL FAILURE:** Do not use damaged equipment. If abnormal noise, vibration, or leaking air occurs, have the problem corrected before further use.

---

### **Cleaning, Maintenance and Lubrication**

**Note:** These procedures are in addition to the regular checks and maintenance explained as part of the regular operation of the Air Compressor.

1. Wipe down the compressor with a clean dry cloth.
2. Check the hoses to be sure there are no cracks or worn areas.
3. Rotate Filter counterclockwise and remove from the compressor. Gently pry the cover from the threaded end. Remove the filter, wash in warm water



- and liquid soap (no harsh powder soap), rinse thoroughly, and let dry
4. Insert back into the filter holder. Align the three indexing ribs on filter housing with the three recessed grooves in the filter cover and push the cover, snapping it onto the housing. Thread the assembly back into the front cover, being careful not to cross thread it.
  5. Lubricate the Shaft (30) and Piston Ring (31) after using 20 times.
    - a. Remove four Screws (4) holding the Front Cover (5) in place and slide the Front Cover off. (See Assembly Diagram.)
    - b. Put a drop or two of machine oil on the Shaft (30) and Piston Ring (31). Note: Turn the Compressor upside down to allow the oil to penetrate onto the piston rings.
    - c. Slide the Front Cover back on and secure in place with the four screws.
  6. If the Fuse (26) needs to be replaced, snap off Fuse cover and then remove and replace Fuse.
  7. Slide out Fuse holder, replace old Fuse with new Fuse included in the inflator nozzle bag, and slide Fuse holder back into slot. Fasten back into place with screws.

## Troubleshooting

Problem	Possible Causes	Likely Solutions
Decreased output.	<ol style="list-style-type: none"> <li>1. Not enough air pressure and/or air flow.</li> <li>2. Blocked air inlet Filter (3).</li> <li>3. Air leaking from loose housing or connections.</li> <li>4. Mechanism contaminated.</li> </ol>	<ol style="list-style-type: none"> <li>1. Check for loose connections.</li> <li>2. Clean air inlet screen of buildup.</li> <li>3. Make sure housing and connections are properly assembled and tight.</li> <li>4. Have qualified technician clean and where possible, lubricate mechanism.</li> </ol>
Severe air leakage. (Slight air leakage is normal, especially on older tools.)	<ol style="list-style-type: none"> <li>1. Cross-threaded housing components.</li> <li>2. Loose housing.</li> <li>3. Damaged valve or housing.</li> <li>4. Dirty, worn or damaged valve.</li> </ol>	<ol style="list-style-type: none"> <li>1. Check for incorrect alignment and uneven gaps. If cross-threaded, disassemble and replace damaged parts before use.</li> <li>2. Tighten housing assembly. If housing cannot be tightened properly, internal parts may be misaligned.</li> <li>3. Replace damaged components.</li> <li>4. Clean or replace valve assembly.</li> </ol>
No output	<ol style="list-style-type: none"> <li>1. Poor clamp connection.</li> <li>2. Power Switch in Off (O) position.</li> <li>3. Run-down battery.</li> <li>4. Blown Fuse.</li> </ol>	<ol style="list-style-type: none"> <li>1. Clean clamps and reconnect properly.</li> <li>2. Turn Power Switch to On (I) position.</li> <li>3. Recharge battery.</li> <li>4. Replace Fuse.</li> </ol>



**Follow all safety precautions whenever diagnosing or servicing the tool. Disconnect from inflated item before service.**

## PARTS LIST

Part	Description	Qty.
1	Base Board	1
2	Pad	4
3	Filter	1
4	Screw 4x8	4
5	Front Cover	1
6	Screw 5x14	4
7	Ring	1
8	Offset Wheel	1
9	Front End Cover	1
10	Decorative Ring	1
11	Nut	4
12	Bearing 6201z	1
13	Armature	1
14	Bearing 608z	1
15	Motor Cover	1
16	Brush Bracket	1
17	Motor Cover Board	1
18	Temperature Controler	1
19	Spring Washer	2
20	Screw 5x150	2
21	Nut	4
22	Decorative Ring	1
23	Rear Cover	1
24	Screw 5x14	4
25	Switch	1
26	Fuse Holder	1
27	Power Cord	1
28	Clamp	2
29	Bearing 6201z	1
30	Shaft	1
31	Piston Ring	1
32	Pressing Ring	1
33	Air Inlet Valve Slice	1
34	Rivet	1
35	Cylinder Liner	1

Part	Description	Qty.
36	Seal Ring	1
37	Air Storage Cap	1
38	Seal Ring	2
39	Air Exhaust	2
40	Rivet	2
41	Seal Ring	1
42	Radiation Cover	1
43	Cylinder Cover 1	1
44	Spring Washer	4
45	Screw 5x50	4
46	Cylinder Cover 2	1
47	Screw 4x12	1
48	Triangle Bracket 1	1
49	Air Hose	1
50	Handle	1
51	Triangle Bracket 2	1
52	Air Hose Connector	1
53	Rubber Hose	1
54	Air Hose Connector	1
55	Air Nozzle	1
56	Air Nozzle Gripe	1
57	Rubber Hose	1
58	Pressure Gauge	1
59	Air Hose	1
60	Quick Connector	1
61	Inflator Nozzle 1	1
62	Inflator Nozzle 2	1
63	Needle Nozzle	1

### Accessory List

Part	Description	Function
61	Inflator Nozzle 1	Medium size fill orifice
62	Inflator Nozzle 2	Small size fill orifice
63	Needle Nozzle	Inflate balls
26A	Fuse, Blade Type	Overload Protection

# ASSEMBLY DIAGRAM

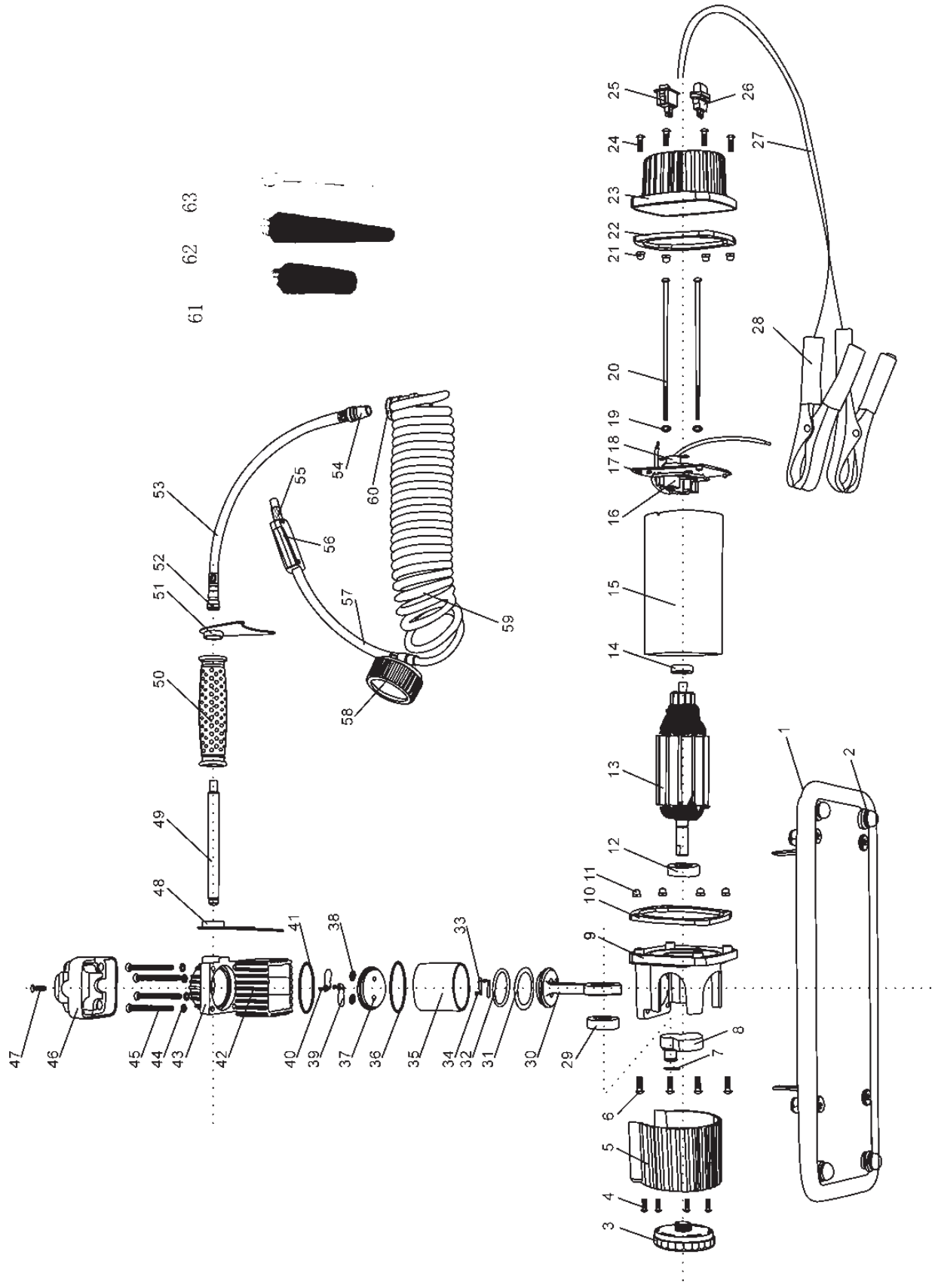

## 90 Day Warranty

Harbor Freight Tools Co. makes every effort to assure that its products meet high quality and durability standards, and warrants to the original purchaser that this product is free from defects in materials and workmanship for the period of 90 days from the date of purchase. This warranty does not apply to damage due directly or indirectly, to misuse, abuse, negligence or accidents, repairs or alterations outside our facilities, criminal activity, improper installation, normal wear and tear, or to lack of maintenance. We shall in no event be liable for death, injuries to persons or property, or for incidental, contingent, special or consequential damages arising from the use of our product. Some states do not allow the exclusion or limitation of incidental or consequential damages, so the above limitation of exclusion may not apply to you. THIS WARRANTY IS EXPRESSLY IN LIEU OF ALL OTHER WARRANTIES, EXPRESS OR IMPLIED, INCLUDING THE WARRANTIES OF MERCHANTABILITY AND FITNESS.

To take advantage of this warranty, the product or part must be returned to us with transportation charges prepaid. Proof of purchase date and an explanation of the complaint must accompany the merchandise. If our inspection verifies the defect, we will either repair or replace the product at our election or we may elect to refund the purchase price if we cannot readily and quickly provide you with a replacement. We will return repaired products at our expense, but if we determine there is no defect, or that the defect resulted from causes not within the scope of our warranty, then you must bear the cost of returning the product.

This warranty gives you specific legal rights and you may also have other rights which vary from state to state.

**3491 Mission Oaks Blvd. • PO Box 6009 • Camarillo, CA 93011 • (800) 444-3353**

**Record Product's Serial Number Here:** \_\_\_\_\_

**Note:** If product has no serial number, record month and year of purchase instead.

**Note:** Some parts are listed and shown for illustration purposes only, and are not available individually as replacement parts.

### **PLEASE READ THE FOLLOWING CAREFULLY**

THE MANUFACTURER AND/OR DISTRIBUTOR HAS PROVIDED THE PARTS LIST AND ASSEMBLY DIAGRAM IN THIS MANUAL AS A REFERENCE TOOL ONLY. NEITHER THE MANUFACTURER OR DISTRIBUTOR MAKES ANY REPRESENTATION OR WARRANTY OF ANY KIND TO THE BUYER THAT HE OR SHE IS QUALIFIED TO MAKE ANY REPAIRS TO THE PRODUCT, OR THAT HE OR SHE IS QUALIFIED TO REPLACE ANY PARTS OF THE PRODUCT. IN FACT, THE MANUFACTURER AND/OR DISTRIBUTOR EXPRESSLY STATES THAT ALL REPAIRS AND PARTS REPLACEMENTS SHOULD BE UNDERTAKEN BY CERTIFIED AND LICENSED TECHNICIANS, AND NOT BY THE BUYER. THE BUYER ASSUMES ALL RISK AND LIABILITY ARISING OUT OF HIS OR HER REPAIRS TO THE ORIGINAL PRODUCT OR REPLACEMENT PARTS THERETO, OR ARISING OUT OF HIS OR HER INSTALLATION OF REPLACEMENT PARTS THERETO.